

**P4R**  
electronics



**9203**

**Solenoid /  
alarm driver**

No. 9203V104-UK

Product version: 9203-002



**CCOE**



- DK** ▶ PR electronics A/S tilbyder et bredt program af analoge og digitale signalbehandlingsmoduler til industriel automation. Programmet består af Isolatorer, Displays, Ex-barrierer, Temperaturtransmittere, Universaltransmittere mfl. Vi har modulerne, du kan stole på i selv barske miljøer med elektrisk støj, vibrationer og temperaturudsving, og alle produkter opfylder de strengeste internationale standarder. Vores motto »Signals the Best« er indbegrebet af denne filosofi - og din garanti for kvalitet.
- UK** ▶ PR electronics A/S offers a wide range of analogue and digital signal conditioning devices for industrial automation. The product range includes Isolators, Displays, Ex Interfaces, Temperature Transmitters, and Universal Devices. You can trust our products in the most extreme environments with electrical noise, vibrations and temperature fluctuations, and all products comply with the most exacting international standards. »Signals the Best« is the epitome of our philosophy - and your guarantee for quality.
- FR** ▶ PR electronics A/S offre une large gamme de produits pour le traitement des signaux analogiques et numériques dans tous les domaines industriels. La gamme de produits s'étend des transmetteurs de température aux afficheurs, des isolateurs aux interfaces SI, jusqu'aux modules universels. Vous pouvez compter sur nos produits même dans les conditions d'utilisation sévères, p.ex. bruit électrique, vibrations et fluctuations de température. Tous nos produits sont conformes aux normes internationales les plus strictes. Notre devise »SIGNALS the BEST« c'est notre ligne de conduite - et pour vous l'assurance de la meilleure qualité.
- DE** ▶ PR electronics A/S verfügt über ein breites Produktprogramm an analogen und digitalen Signalverarbeitungsgeräte für die industrielle Automatisierung. Dieses Programm umfasst Displays, Temperaturtransmitter, Ex- und galvanische Signaltrenner, und Universalgeräte. Sie können unsere Geräte auch unter extremen Einsatzbedingungen wie elektrisches Rauschen, Erschütterungen und Temperaturschwingungen vertrauen, und alle Produkte von PR electronics werden in Übereinstimmung mit den strengsten internationalen Normen produziert. »Signals the Best« ist Ihre Garantie für Qualität!

# SOLENOID / ALARM DRIVER

9203

## CONTENTS

Warning.....	2
Symbol identification .....	2
Safety instructions.....	2
How to demount system 9000 .....	4
Advanced features .....	5
Application.....	5
Technical characteristics.....	5
Applications.....	6
PR 4501 Display / programming front.....	7
Mounting / demounting the PR4501/4511.....	8
Order: 9203B.....	9
Accessories .....	9
Electrical specifications.....	9
Visualisation in 4501 of hardware / software error .....	14
Connections .....	15
Block diagram.....	16
Signal error indications without display front.....	17
Configuration / operating the function keys.....	17
Routing diagram.....	19
Routing diagram, Advanced settings (ADV.SET).....	20
Scrolling help texts in display line 3.....	21
Appendix .....	22
IECEX Installation Drawing.....	23
ATEX Installation Drawing.....	26
FM Installation Drawing .....	29
INMETRO Installation Drawing.....	31
Safety Manual.....	35



## WARNING

The following operations should only be carried out on a disconnected device and under ESD-safe conditions:

- General mounting, connection and disconnection of wires.
- Troubleshooting the device.

**Repair of the device and replacement of circuit breakers must be done by PR electronics A/S only.**



## WARNING

Do not open the front plate of the device as this will cause damage to the connector for the display / programming front PR 4501. This device contains no DIP-switches or jumpers.

## SYMBOL IDENTIFICATION



**Triangle with an exclamation mark:** Read the manual before installation and commissioning of the device in order to avoid incidents that could lead to personal injury or mechanical damage.



**The CE mark** proves the compliance of the device with the essential requirements of the directives.



**The double insulation symbol** shows that the device is protected by double or reinforced insulation.



**Ex devices** have been approved according to the ATEX directive for use in connection with installations in explosive areas. See installation drawings in appendix.

## SAFETY INSTRUCTIONS

### DEFINITIONS

**Hazardous voltages** have been defined as the ranges: 75...1500 Volt DC, and 50...1000 Volt AC.

**Technicians** are qualified persons educated or trained to mount, operate, and also troubleshoot technically correct and in accordance with safety regulations.

**Operators**, being familiar with the contents of this manual, adjust and operate the knobs or potentiometers during normal operation.

## **RECEIPT AND UNPACKING**

Unpack the device without damaging it and check whether the device type corresponds to the one ordered. The packing should always follow the device until this has been permanently mounted.

## **ENVIRONMENT**

Avoid direct sunlight, dust, high temperatures, mechanical vibrations and shock, as well as rain and heavy moisture. If necessary, heating in excess of the stated limits for ambient temperatures should be avoided by way of ventilation.

The device must be installed in pollution degree 2 or better.

The device is designed to be safe at least under an altitude up to 2 000 m.

## **MOUNTING**

Only technicians who are familiar with the technical terms, warnings, and instructions in the manual and who are able to follow these should connect the device.

Should there be any doubt as to the correct handling of the device, please contact your local distributor or, alternatively,

**PR electronics A/S**  
**[www.prelectronics.com](http://www.prelectronics.com)**

The use of stranded wires is not permitted for mains wiring except when wires are fitted with cable ends.

Descriptions of input / output and supply connections are shown in the block diagram and on the side label.

The device is provided with field wiring terminals and shall be supplied from a Power Supply having double / reinforced insulation. A power switch shall be easily accessible and close to the device. The power switch shall be marked as the disconnecting unit for the device.

For installation on Power Rail 9400 the power is supplied by Power Control Unit 9410.

Year of manufacture can be taken from the first two digits in the serial number.

## **CALIBRATION AND ADJUSTMENT**

During calibration and adjustment, the measuring and connection of external voltages must be carried out according to the specifications of this manual. The technician must use tools and instruments that are safe to use.

## **NORMAL OPERATION**

Operators are only allowed to adjust and operate devices that are safely fixed in panels, etc., thus avoiding the danger of personal injury and damage. This means there is no electrical shock hazard, and the device is easily accessible.

## **CLEANING**

When disconnected, the device may be cleaned with a cloth moistened with distilled water.

## **LIABILITY**

To the extent that the instructions in this manual are not strictly observed, the customer cannot advance a demand against PR electronics A/S that would otherwise exist according to the concluded sales agreement.

## **HOW TO DEMOUNT SYSTEM 9000**

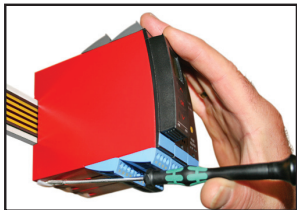

**Picture 1:**

By lifting the bottom lock, the device is detached from the DIN rail.

# SOLENOID / ALARM DRIVER 9203

- *Universal Ex driver for solenoids, acoustic alarms and LEDs*
- *Extended self-diagnostics*
- *1 or 2 channels*
- *Can be supplied separately or installed on power rail, PR 9400*
- *SIL 2-certified via Full Assessment*

## **Advanced features**

- Universal Ex driver for the control of solenoids etc. with various Ex data by way of three built-in Ex barriers.
- Two hardware versions make it possible to choose either Low (35 mA) or High (60 mA) current output.
- Configuration and monitoring by way of detachable display front (PR 4501).
- Selection of direct or inverted function for each channel via PR 4501 and the possibility of reducing the output current to the hazardous area to suit the application.
- Optional monitoring of the output current to the hazardous area by way of PR 4501.
- Optional redundant supply via power rail and/or separate supply.

## **Application**

- The device can be mounted in the safe area or in zone 2 / div. 2 and transmit signals to zone 0, 1, 2 and zone 20, 21, 22 including M1 mining / Class I/II/III, Div. 1, Gr. A-G.
- Ex driver for the control of ON / OFF solenoids, acoustic alarms and LEDs mounted in the hazardous area.
- The 9203 is controlled by an NPN/PNP signal or a switch signal.
- Monitoring of internal error events via the individual status relay and/or a collective electronic signal via the power rail.
- The 9203 has been designed, developed and certified for use in SIL 2 applications according to the requirements of IEC 61508.

## **Technical characteristics**

- 1 green and 2 yellow/red front LEDs indicate operation status and malfunction.
- 2.6 kVAC galvanic isolation between input, output and supply.

# APPLICATIONS

Output signals:

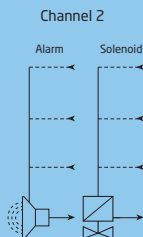

**Zone 0, 1, 2,  
20, 21, 22, M1 &  
Cl. I/II/III, div. 1  
gr. A-G**

Input signals:

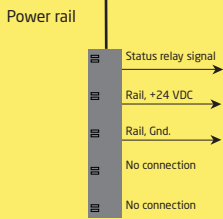
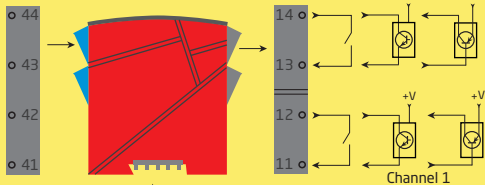

Power connection:

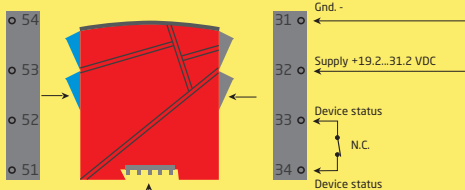

**Zone 2 / Cl. 1, div. 2, gr. A-D or safe area**



# PR 4501 DISPLAY / PROGRAMMING FRONT



## Functionality

The simple and easily understandable menu structure and the explanatory help texts guide you effortlessly and automatically through the configuration steps, thus making the product very easy to use. Functions and configuration options are described in the section "Configuration / operating the function keys".

## Application

- Communications interface for modification of operational parameters in 9203.
- When mounted in the process, the display shows process values and device status.

## Technical characteristics

- LCD display with 4 lines; Line 1 (H=5.57 mm) shows status for each channel (OK or error). Line 2 (H=3.33 mm) shows output for channel 1 (ON / OFF), line 3 (H=3.33 mm) shows output for channel 2 (ON / OFF), and line 4 shows whether the device is SIL-locked. Static dot = SIL-locked and flashing dot = not SIL-locked. Line 4 also indicates if the output is active.
- In order to protect the configuration against unauthorised changes, access to the menus can be blocked by a password.

## MOUNTING / DEMOUNTING THE PR 4501/4511

1: Insert the taps of 4501/4511 into the holes at the top of the device.

2: Swing 4501/4511 into place.

### Demounting of 4501/4511

3: Push the release button on the bottom of 4501/4511 and swing 4501/4511 up.

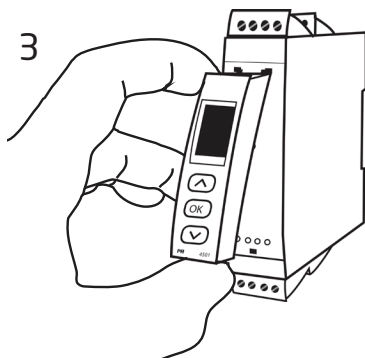
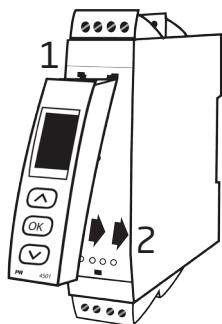

Order: 9203B

Type	Ex barrier [Ex ia]	Channels
9203B	Low current . . . . : 1	Single . . . . : A Double . . . . : B
	High current . . . . : 2	Single . . . . : A

## Accessories

Type	Description
4501	Display / programming front
4511	Communication enabler
9400	Power rail
9404	Module stop for rail
9410	Power control unit
9420	Power supply 24 V / 120 W - Ex nAC

## Electrical specifications

### Environmental conditions

Specifications range.....	-20...+60°C
Storage temperature .....	-20...+85°C
Calibration temperature .....	20...28°C
Relative humidity.....	< 95% RH (non-cond.)
Protection degree.....	IP20
Installation in.....	Pollution degree 2 & measurement / overvoltage category II

### Mechanical specifications:

Dimensions (HxWxD).....	109 x 23.5 x 104 mm
Dimensions (HxWxD) w/ 4501 / 4511.....	109 x 23.5 x 116 / 131 mm
Weight approx.....	170 g
Weight incl. 4501 / 4511 (approx.).....	185 g / 270 g
DIN rail type.....	DIN EN 60715/35 mm
Wire size .....	0.13...2.08 mm <sup>2</sup> AWG 26...14 stranded wire
Screw terminal torque .....	0.5 Nm
Vibration: 2...13.2 Hz.....	±1 mm
Vibration: 13.2...100 Hz.....	±0.7 g

**Common specifications:**

Supply voltage.....	19.2...31.2 VDC
Max. consumption.....	≤ 3.5 W (2 channels)
Fuse.....	1.25 A SB / 250 VAC
Isolation voltage, test / operation:	
Input / output / supply .....	2.6 kVAC / 250 VAC
Output 1 to output 2.....	1.5 kVAC / 150 VAC reinforced
Status relay to supply .....	1.5 kVAC / 150 VAC reinforced
Communications interface .....	Communication enabler 4511 / Programming front 4501

EMC immunity influence .....	< ±0.5% of span
Extended EMC immunity:	
NAMUR NE 21, A criterion, burst .....	< ±1% of span

**NPN and mechanical switch:**

Trig level LOW .....	≤ 2.0 VDC
Trig level HIGH.....	≥ 4.0 VDC
Max. external voltage.....	28 VDC
Input impedance .....	3.50 kΩ

**PNP:**

Trig level LOW .....	≤ 8.0 VDC
Trig level HIGH.....	≥ 10.0 VDC
Max. external voltage.....	28 VDC
Input impedance .....	3.50 kΩ

**Special PNP trig input:**

If the input signal comes from a device where the output is connected as an open collector with pull up resistor, a diode must be connected in series with the input signal. See connections drawing at page 14 for further details.

**Outputs:**

Output ripple .....	< 40 mV RMS
---------------------	-------------

## Output loads

Terminal	9203B1A (1 channel) / 9203B1B (2 channels)		
	41-42 / 51-52	41-43 / 51-53	41-44 / 51-54
Vout. no load	Min. 24 V	Min. 24 V	Min. 24 V
Vout. with load	Min. 12.5 V	Min. 13.5 V	Min. 14.5 V
Iout. max	35 mA	35 mA	35 mA

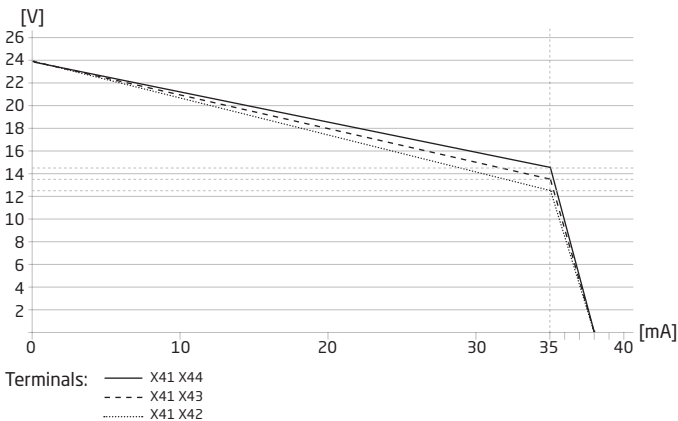

Terminal	9203B2A (1 channel)					
	41-42		41-43		41-44	
Vout. no load	Min. 24 V		Min. 24 V		Min. 24 V	
Vout. with load	Min. 11.5 V	Min. 9 V	Min. 12.5 V	Min. 10 V	Min. 13.5 V	Min. 11 V
Iout. max	50 mA	60 mA	50 mA	60 mA	50 mA	60 mA

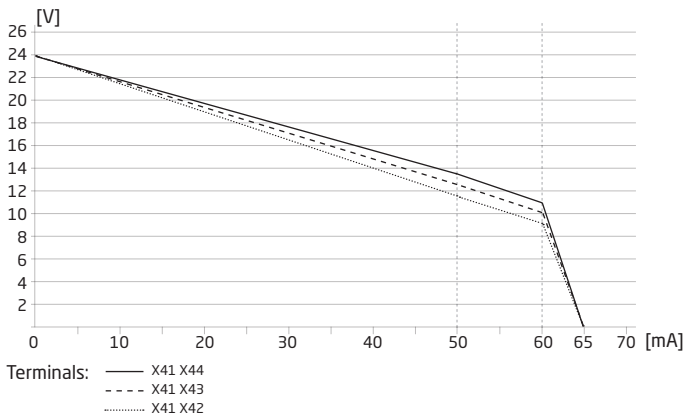

**Relay output:**

## Status relay in safe area:

Max. voltage.....	125 VAC / 110 VDC
Max. current .....	0.5 A AC / 0.3 A DC
Max. power .....	62.5 VA / 32 W

**Approvals:**

EMC 2004/108/EC .....	EN 61326-1
LVD 2006/95/EC.....	EN 61010-1
c UL us, Standard for Safety.....	UL 61010-1
EAC TR-CU 020/2011.....	EN 61326-1

**Marine:**

Det Norske Veritas, Ships & Offshore .....	Stand. f. Certific. No. 2.4
--	-----------------------------

**I.S. / Ex:**

ATEX 94/9/EC.....	KEMA 07ATEX0147 X
IECEX .....	IECEX KEM 09.0001X
c FM us .....	3035277-C
INMETRO .....	NCC 12.1306 X
CCOE.....	P337349/6
EAC Ex TR-CU 012/2011 .....	RU C-DK.GB08.V.00410

**Functional Safety:**

SIL2 Certified & Fully Assessed acc. to IEC 61508

## Visualisation in 4501 of hardware / software error

Readout at hardware error:		
Error search	Readout	Cause
Communications test 4501 / 9203	NO.CO	Connection error
EEProm error - check configuration	FL.ER	Configuration error or crc mismatch, recovery configuration is loaded
Hardware error	DE.ER	Invalid recovery configuration in device
Hardware error	FC.ER	Invalid code checksum in 4501
EEProm error - check configuration	CO.ER	Invalid configuration (CRC or data)
Hardware error	CA.ER	Factory calibration error
Hardware error	HW.ER	HW setup - configuration mismatch
Hardware error	OC.ER	Main output controller communication error
Hardware error	MS.ER	Main internal supply out of bounds
Hardware error	MI.ER	Main initialisation selftest failed
Hardware error	MC.ER	Main flash or ram selftest failed



# CONNECTIONS

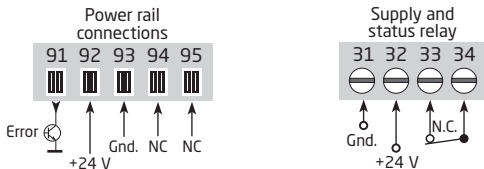

NC = No connection

## Inputs:

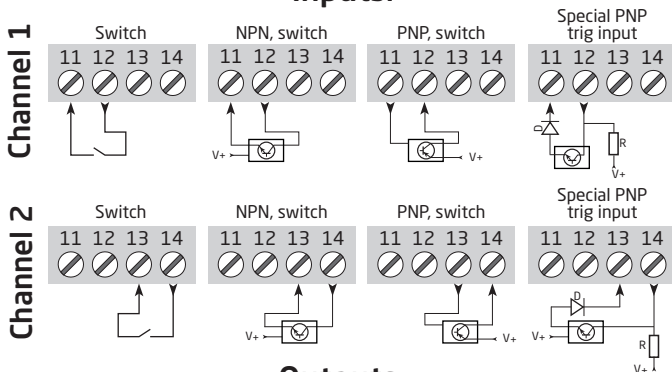

## Outputs:

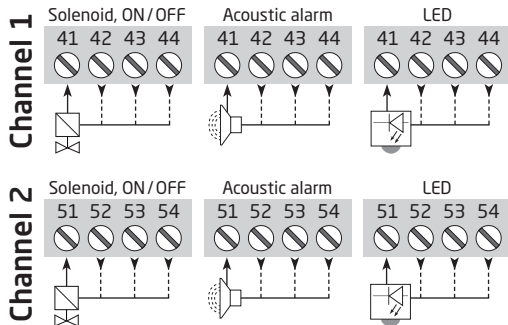

# BLOCK DIAGRAM

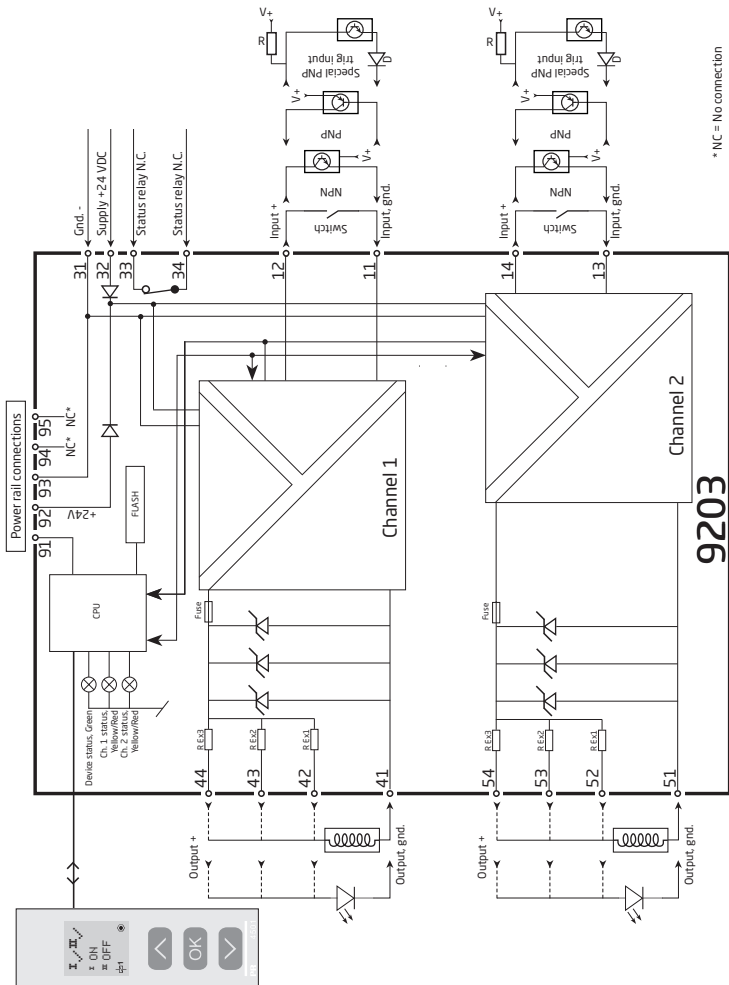

\* NC = No connection

# 9203

## Signal error indications without display front

LED and error signal indications					
State	Green LED	Ch 1: Yellow / Red	Ch 2: Yellow / Red	Status relay, N.C.	Power rail signal status
Device OK	Flashing			Energised	OFF
No supply	OFF	OFF	OFF	De-energised	ON
Device defective	OFF	Red	Red	De-energised	ON
Ch. 1, output ON	Flashing	Yellow		Energised	OFF
Ch. 1, output OFF	Flashing	OFF		Energised	OFF
Ch. 2, output ON	Flashing		Yellow	Energised	OFF
Ch. 2, output OFF	Flashing		OFF	Energised	OFF

## CONFIGURATION / OPERATING THE FUNCTION KEYS

Documentation for routing diagram.

### In general

When configuring the 9203, you will be guided through all parameters and you can choose the settings which fit the application. For each menu there is a scrolling help text which is automatically shown in line 3 on the display.

Configuration is carried out by use of the 3 function keys:

- ⬆ will increase the numerical value or choose the next parameter
- ⬇ will decrease the numerical value or choose the previous parameter
- Ⓞ will accept the chosen value and proceed to the next menu

When configuration is completed, the display will return to the default state 1.0.

Pressing and holding Ⓞ will return to the previous menu or return to the default state (1.0) without saving the changed values or parameters.

If no key is activated for 1 minute, the display will return to the default state (1.0) without saving the changed values or parameters.

## Further explanations

**Password protection:** Programming access can be blocked by assigning a password. The password is saved in the device in order to ensure a high degree of protection against unauthorised modifications to the configuration. Default password 2008 allows access to all configuration menus.

## Signal and device error information via display front 4501

The display front can be configured to show output status, output current or tag no. for both channels. In case of hardware error, a help text explaining the error will be displayed.

## Advanced functions

The unit gives access to a number of advanced functions which can be reached by answering "Yes" to the point "adv.set".

**Display setup:** Here you can adjust the brightness contrast and the backlight. Setup of TAG numbers with 5 alphanumeric. Selection of functional readout in line 2 and 3 of the display - choose between readout of output status, output current or tag no. When selecting "ALT" the readout toggles between the display options.

**Password:** Here you can choose a password between 0000 and 9999 in order to protect the device against unauthorised modifications to the configuration. The device is delivered default without password.

**Language:** In the menu "LANG" you can choose between 7 different language versions of help texts that will appear in the menu. You can choose between UK, DE, FR, IT, ES, SE and DK.

**Safety Integrity Level (SIL):** See Safety Manual for details.



## ROUTING DIAGRAM

If no key is activated for 1 minute, the display will return to the default state 1.0 without saving configuration changes.

- ⤴ Increase value / choose next parameter
- ⤵ Decrease value / choose previous parameter
- ⊗ Accept the chosen value and proceed to the next menu
- Hold ⊗ Back to previous menu / return to menu 1.0 without saving

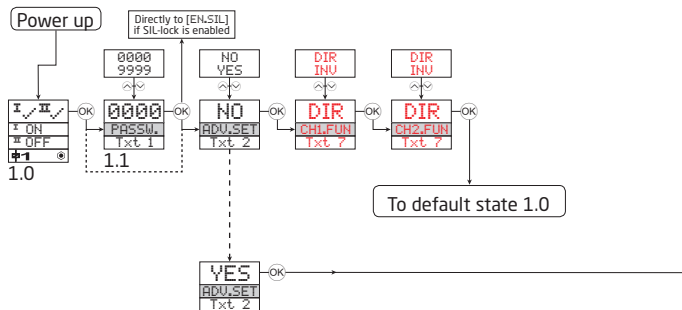

1.0 = Default state

Line 1 shows status for channel 1 and channel 2.

Line 2 shows output status for channel 1, output current or tag no.

Line 3 shows output status for channel 2, output current or tag no.

Line 4 indicates whether the device is SIL-locked.

1.1 = Only if password-protected.

1.2 = If password has been set.

Line 1 symbols:

✓ = OK. Flashing ✖ = error.

Line 2 and 3 symbols:

1 ON = channel 1 ON

2 OFF = channel 2 OFF.

Line 4 symbols:

Static dot = SIL-locked.

Flashing dot = Not SIL-locked.

⊕ = output is active.

Red text signifies safety parameters in a SIL configuration. See safety manual for details

## ROUTING DIAGRAM, ADVANCED SETTINGS (ADV.SET)

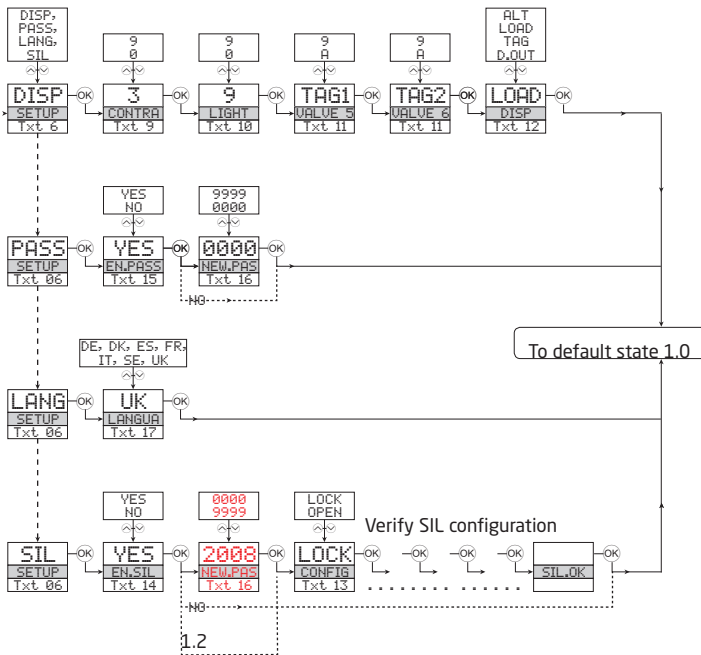

## SCROLLING HELP TEXTS IN DISPLAY LINE 3

- [01] Set correct password
- [02] Enter advanced setup?
- [06] Enter language setup  
Enter password setup  
Enter display setup  
Enter SIL setup
- [07] Select direct channel function  
Select inverted channel function
- [09] Adjust LCD contrast
- [10] Adjust LCD backlight
- [11] Write a 5-character channel tag
- [12] Show output state in display  
Show output load in display  
Show tag in display  
Alternate information shown in display
- [13] Configuration SIL status (Open / Locked)
- [14] Enable SIL configuration lock
- [15] Enable password protection?
- [16] Set new password
- [17] Select language
- [20] No communication - check connections
- [21] Eeprom error - check configuration
- [22] Hardware error

# **APPENDIX**

**IECEX INSTALLATION DRAWING**

**ATEX INSTALLATION DRAWING**

**FM INSTALLATION DRAWING**

**INMETRO INSTALLATION DRAWING**

**SAFETY MANUAL**



## IECEX Installation drawing



For safe installation of 9203B the following must be observed. The module shall only be installed by qualified personnel who are familiar with the national and international laws, directives and standards that apply to this area.

Year of manufacture can be taken from the first two digits in the serial number.



For Installation in Zone 2 / Division 2 the following must be observed. The 4501 programming module is to be used solely with PRelectronics modules. It is important that the module is undamaged and has not been altered or modified in any way. Only 4501 modules free of dust and moisture shall be installed.

**IECEX Certificate:** IECEX KEM 09.0001X

**Marking**  
 [Ex ia Ga] IIC/IIB/IIA  
 Ex nA nC IIC T4 Gc  
 [Ex ia Da] IIIC  
 [Ex ia Ma] I

**Standards** IEC60079-15:2005, IEC60079-11:2011, IEC60079-0:2011  
 IEC60079-26:2006

### Installation notes.

Install in pollution degree 2, overvoltage category II as defined in IEC60664-1

Do not separate connectors when energized and an explosive gas mixture is present.

Do not mount or remove modules from the Power Rail when an explosive gas mixture is present.

Disconnect power before servicing.

The wiring of unused terminals is not allowed.

In type of protection [Ex ia Da] the parameters for intrinsic safety for gas group IIB are applicable.

For installation in Zone 2, the module shall be installed in an enclosure in type of protection Ex n or Ex e, providing a degree of protection of at least IP54. Cable entry devices and blanking elements shall fulfill the same requirements.

For installation on Power Rail in Zone 2, only Power Rail type 9400 supplied by Power Control Unit type 9410 (Type Examination Certificate KEMA 07ATEX0152 X) is allowed.

Revision date:  
2011-11-20

Version Revision  
V5 R0

Prepared by:  
PB

Page:  
1/3

Hazardous area  
Zone 0, 1, 2, 20, 21, 22

Non Hazardous area  
or Zone 2

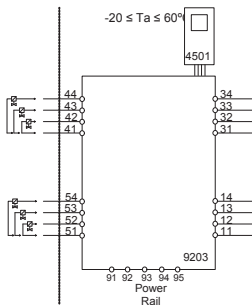

**Supply / Input**  
(terminal 11,12,13,14)  
(terminal 31,32,33,34)  
(terminal 91,92,93,94,95)  
 $U_m$ : 253V, max. 400Hz

**Terminal (31,32)**

**Supply:**

Voltage 19.2 – 31.2 VDC  
Power max. 3.5 W

**Terminal (11,12 and 13,14)**

**Input:**

Voltage max 28VDC  
Trig: NPN Low < 2 V, High > 4 V  
Trig: PNP Low < 8 V, High > 10 V

**Terminal (33,34)**

**Status Relay:**

Voltage max. 125 VAC / 110 VDC  
Power max. 62.5 VA / 32 W  
Current max. 0.5 AAC / 0.3 ADC

**Non Hazardous location**

**Zone 2 installation**

32 VAC / 32 VDC  
16 VA / 32 W  
0.5 AAC / 1 ADC

9203B1A, 9203B1B Terminal 41-42/51-52			Co	Lo	Lo/Ro	9203B2A Terminal 41-42			Co	Lo	Lo/Ro
U <sub>o</sub>	28V	IIC	80nF	4.2mH	54μH/Ω	U <sub>o</sub>	28V	IIC	80nF	2.69mH	44μH/Ω
I <sub>o</sub>	93 mA	IIB	640nF	16.8mH	218μH/Ω	I <sub>o</sub>	115mA	IIB	640nF	10.8mH	176μH/Ω
P <sub>o</sub>	0.65W	IIA	2.1μF	32.6mH	436μH/Ω	P <sub>o</sub>	0.81W	IIA	2.1μF	20.8mH	353μH/Ω
		I	3.76μF	32.6mH	436μH/Ω			I	3.76μF	20.8mH	353μH/Ω
9203B1A, 9203B1B Terminal 41-43/51-53			Co	Lo	Lo/Ro	9203B2A Terminal 41-43			Co	Lo	Lo/Ro
U <sub>o</sub>	28V	IIC	80nF	3.5mH	50μH/Ω	U <sub>o</sub>	28V	IIC			
I <sub>o</sub>	100mA	IIB	640nF	14.2mH	201μH/Ω	I <sub>o</sub>	125mA	IIB	640nF	9.1mH	163μH/Ω
P <sub>o</sub>	0.70W	IIA	2.1μF	27.6mH	402μH/Ω	P <sub>o</sub>	0.88W	IIA	2.1μF	17.6mH	327μH/Ω
		I	3.76μF	27.6mH	402μH/Ω			I	3.76μF	17.6mH	327μH/Ω
9203B1A, 9203B1B Terminal 41-44/51-54			Co	Lo	Lo/Ro	9203B2A Terminal 41-44			Co	Lo	Lo/Ro
U <sub>o</sub>	28V	IIC	80nF	2.9mH	46μH/Ω	U <sub>o</sub>	28V	IIC			
I <sub>o</sub>	110mA	IIB	640nF	11.8mH	184μH/Ω	I <sub>o</sub>	135mA	IIB	640nF	7.8mH	150μH/Ω
P <sub>o</sub>	0.77W	IIA	2.1μF	22.8mH	369μH/Ω	P <sub>o</sub>	0.95W	IIA	2.1μF	15.1mH	301μH/Ω
		I	3.76μF	22.8mH	369μH/Ω			I	3.76μF	15.1mH	301μH/Ω

## ATEX Installation drawing



For safe installation of 9203B the following must be observed. The module shall only be installed by qualified personnel who are familiar with the national and international laws, directives and standards that apply to this area.

Year of manufacture can be taken from the first two digits in the serial number.



For installation in Zone 2 / Division 2 the following must be observed.

The 4501 programming module is to be used solely with PR electronics modules. It is important that the module is undamaged and has not been altered or modified in any way. Only 4501 modules free of dust and moisture shall be installed.

**ATEX Certificate** KEMA 07ATEX 0147 X

**Marking**



II (1) G [Ex ia Ga] IIC/IIB/IIA  
 II 3G Ex nA nC IIC T4 Gc  
 I (1) D [Ex ia Da] IIIC  
 I (M1) [Ex ia Ma] I

**Standards**

EN 60079-0 : 2009, EN 60079-11 : 2007, EN 60079-15 : 2005  
 EN 60079-26 : 2007, EN 61241-11 : 2006

**Terminal (31,32)**

Supply:  
 Voltage 19.2 – 31.2 VDC  
 Power max. 3.5 W

**Terminal (11,12 and 13,14)**

Input:  
 Voltage max 28VDC  
 Trig: NPN Low < 2 V, High > 4 V  
 Trig: PNP Low < 8 V, High > 10 V

**Terminal (33,34)**

Status Relay:	Non Hazardous location	Zone 2 installation
Voltage max.	125 VAC / 110 VDC	32 VAC / 32 VDC
Power max.	62.5 VA / 32 W	16 VA / 32 W
Current max.	0.5 AAC / 0.3 ADC	0.5 AAC / 1 ADC

**Installation notes.**

Install in pollution degree 2, overvoltage category II as defined in EN60664-1

Do not separate connectors when energized and an explosive gas mixture is present.  
 Do not mount or remove modules from the Power Rail when an explosive gas mixture is present.  
 Disconnect power before servicing.

The wiring of unused terminals is not allowed.

In type of protection [Ex ia Da] the parameters for intrinsic safety for gas group IIB are applicable.

For installation in Zone 2, the module shall be installed in an enclosure in type of protection Ex n or Ex e, providing a degree of protection of at least IP54. Cable entry devices and blanking elements shall fulfill the same requirements.

For installation on Power Rail in Zone 2, only Power Rail type 9400 supplied by Power Control Unit type 9410 (Type Examination Certificate KEMA 07ATEX0152 X) is allowed.

Hazardous area  
Zone 0,1,2, 20, 21, 22

Non Hazardous Area  
or Zone 2

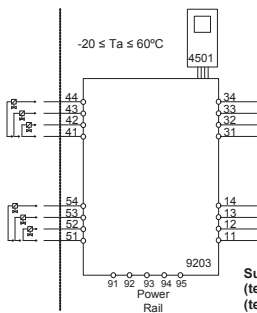

**Supply / Input**  
**(terminal 11,12,13,14)**  
**(terminal 31,32,33,34)**  
**(terminal 91,92,93,94,95)**  
 U<sub>m</sub>: 253 V, max. 400 Hz

9203B1A, 9203B1B Terminal 41-42/51-52						Co	Lo	Lo/Ro	9203B2A Terminal 41-42						Co	Lo	Lo/Ro
U <sub>o</sub>	28V	IIC	80nF	4.2mH	54μH/Ω				U <sub>o</sub>	28V	IIC	80nF	2.69mH	44μH/Ω			
I <sub>o</sub>	93 mA	IIB	640nF	16.8mH	218μH/Ω				I <sub>o</sub>	115mA	IIB	640nF	10.8mH	176μH/Ω			
P <sub>o</sub>	0.65W	IIA	2.1μF	32.6mH	436μH/Ω				P <sub>o</sub>	0.81W	IIA	2.1μF	20.8mH	353μH/Ω			
		I	3.76μF	32.6mH	436μH/Ω						I	3.76μF	20.8mH	353μH/Ω			
9203B1A, 9203B1B Terminal 41-43/51-53						Co	Lo	Lo/Ro	9203B2A Terminal 41-43						Co	Lo	Lo/Ro
U <sub>o</sub>	28V	IIC	80nF	3.5mH	50μH/Ω				U <sub>o</sub>	28V	IIC						
I <sub>o</sub>	100mA	IIB	640nF	14.2mH	201μH/Ω				I <sub>o</sub>	125mA	IIB	640nF	9.1mH	163μH/Ω			
P <sub>o</sub>	0.70W	IIA	2.1μF	27.6mH	402μH/Ω				P <sub>o</sub>	0.88W	IIA	2.1μF	17.6mH	327μH/Ω			
		I	3.76μF	27.6mH	402μH/Ω						I	3.76μF	17.6mH	327μH/Ω			
9203B1A, 9203B1B Terminal 41-44/51-54						Co	Lo	Lo/Ro	9203B2A Terminal 41-44						Co	Lo	Lo/Ro
U <sub>o</sub>	28V	IIC	80nF	2.9mH	46μH/Ω				U <sub>o</sub>	28V	IIC						
I <sub>o</sub>	110mA	IIB	640nF	11.8mH	184μH/Ω				I <sub>o</sub>	135mA	IIB	640nF	7.8mH	150μH/Ω			
P <sub>o</sub>	0.77W	IIA	2.1μF	22.8mH	369μH/Ω				P <sub>o</sub>	0.95W	IIA	2.1μF	15.1mH	301μH/Ω			
		I	3.76μF	22.8mH	369μH/Ω						I	3.76μF	15.1mH	301μH/Ω			

## FM Installation drawing



For safe installation of 9203B the following must be observed. The module shall only be installed by qualified personnel who are familiar with the national and international laws, directives and standards that apply to this area.

Year of manufacture can be taken from the first two digits in the serial number.



For Installation in Zone 2 / Division 2 the following must be observed.

The 4501 programming module is to be used solely with PRelectronics modules. It is important that the module is undamaged and has not been altered or modified in any way. Only 4501 modules free of dust and moisture shall be installed.

c-FM-us Certificate

3035277

### Hazardous area

Class I/II/III, Division 1, Group A,B,C,D,E,F,G  
or Class I, Zone 0/1 Group IIC, [AEx ia] IIC or  
or Class I, Zone 0/1 Group IIC, [Ex ia] IIC

### Non Hazardous Area or

Class I, Division 2, Group A,B,C,D T4  
or Class I, Zone 2 Group IIC T4

Simple Apparatus or  
Intrinsically safe apparatus  
with entity parameters:  
 $V_{max}(U_i) \geq V_t(U_o)$   
 $I_{max}(I_i) \geq I_t(I_o)$   
 $P_i \geq P_t(P_o)$   
 $C_a(C_o) \geq C_{cable} + C_i$   
 $L_a(L_o) \geq L_{cable} + L_i$

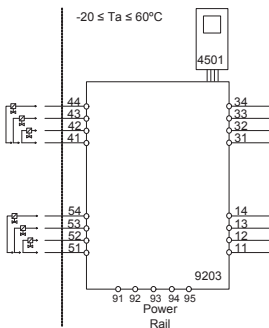

### Supply / Input

(terminal 11,12,13,14)

(terminal 31,32,33,34)

(terminal 91,92,93,94,95)

$U_m$ : 253V, max. 400Hz

**LERBAKKEN 10, 8410 RØNDE DENMARK**

Module 9203B1A & 9203B1B Terminal 41-42 / 51-52				Co/Ca	Lo/La	Lo/Ro or La/Ra
Uo/Voc	28 V	IIC or AB	80 nF	4.2 mH	54 $\mu$ H/D	
Io/Isc	93 mA	IIB or C.E.F	640 nF	16.8 mH	218 $\mu$ H/D	
Po	0.65 W	IIA or D.G	2.1 $\mu$ F	32.6 mH	436 $\mu$ H/D	

Module 9203B2A Terminal 41-42				Co/Ca	Lo/La	Lo/Ro or La/Ra
Uo/Voc	28 V	IIC or AB	80 nF	2.69 mH	44 $\mu$ H/D	
Io/Isc	115 mA	IIB or C.E.F	640 nF	10.8 mH	176 $\mu$ H/D	
Po	0.81 W	IIA or D.G	2.1 $\mu$ F	20.8 mH	353 $\mu$ H/D	

Module 9203B1A & 9203B1B Terminal 41-43 / 51-53				Co/Ca	Lo/La	Lo/Ro or La/Ra
Uo/Voc	28 V	IIC or AB	80 nF	3.5 mH	50 $\mu$ H/D	
Io/Isc	100 mA	IIB or C.E.F	640 nF	14.2 mH	201 $\mu$ H/D	
Po	0.70 W	IIA or D.G	2.1 $\mu$ F	27.6 mH	402 $\mu$ H/D	

Module 9203B2A Terminal 41-43				Co/Ca	Lo/La	Lo/Ro or La/Ra
Uo/Voc	28 V	IIC or AB	80 nF	9.1 mH	163 $\mu$ H/D	
Io/Isc	125 mA	IIB or C.E.F	640 nF	17.6 mH	327 $\mu$ H/D	
Po	0.88 W	IIA or D.G	2.1 $\mu$ F	17.6 mH	327 $\mu$ H/D	

Module 9203B1A & 9203B1B Terminal 41-44 / 51-54				Co/Ca	Lo/La	Lo/Ro or La/Ra
Uo/Voc	28 V	IIC or AB	80 nF	2.9 mH	46 $\mu$ H/D	
Io/Isc	110 mA	IIB or C.E.F	640 nF	11.8 mH	184 $\mu$ H/D	
Po	0.77 W	IIA or D.G	2.1 $\mu$ F	22.8 mH	369 $\mu$ H/D	

Module 9203B2A Terminal 41-44				Co/Ca	Lo/La	Lo/Ro or La/Ra
Uo/Voc	28 V	IIC or AB	80 nF	7.8 mH	150 $\mu$ H/D	
Io/Isc	135 mA	IIB or C.E.F	640 nF	15.1 mH	301 $\mu$ H/D	
Po	0.95 W	IIA or D.G	2.1 $\mu$ F	15.1 mH	301 $\mu$ H/D	

**Terminal (31,32)**
**Supply:**

Voltage	19.2 – 31.2 VDC
Power max.	3.5 W

**Terminal (11,12 and 13,14)**
**Input:**

Voltage	max 28VDC
Trig: NPN	Low < 2V, High > 4V
Trig: PNP	Low < 8V, High > 10V

**Terminal (33,34)**
**Status Relay:**

Voltage max.	125 VAC / 110 VDC
Power max.	62.5 VA / 32 W
Current max.	0.5 AAC / 0.3 ADC

**Non Hazardous location: Division 2 or Zone 2 installation:**

32 VAC / 32VDC
16 VA / 32 W
0.5 AAC / 1 ADC

**Installation notes:**

The installation and wiring shall be in accordance with the Canadian Electrical Code for Canada and National Electrical Code NFPA 70, Article 500 or 505 for installation in USA.

The module must be supplied from a Power Supply having double or reinforced insulation.

The use of stranded wires is not permitted for mains wiring except when wires are fitted with cable ends.

For installation on the 9400 Power Rail the power must be supplied from Power Control Module Unit 9410.

Install in pollution degree 2, overvoltage category II.

The module must be installed in an enclosure suitable for the environment for which it is used.

For installation in Zone 2 or Division 2, the module must be installed in a suitable outer enclosure according to the regulations in the CEC for Canada or NEC for USA.

The module is galvanically isolated and does not require grounding.

Use 60 / 75 °C copper conductors with wire size AWG: (26-14).

The maximum internal Power dissipation for adjacent modules is assumed to be max. 2W each.

**Warning:** Substitution of components may impair intrinsic safety and / or suitability for Div. 2 / Zone 2.

**Warning:** To prevent ignition of explosive atmospheres, disconnect power before servicing and do not separate connectors when energized and an explosive gas mixture is present.

**Warning:** Do not mount or remove modules from the Power Rail when an explosive gas mixture is present.



## INMETRO Desenhos para Instalação



Para instalação segura do 9203B o manual seguinte deve ser observado. O módulo deve ser instalado somente por profissionais qualificados que estão familiarizados com as leis nacionais e internacionais, diretrizes e normas que se aplicam a esta área.

Ano de fabricação pode ser obtido a partir dos dois primeiros dígitos do número de série.



### 4501

Para a instalação na Zona 2 o seguinte deve ser observado. O módulo de programação de 4501, deve ser utilizado apenas com os módulos PRelectronics. É importante que o módulo esteja intacto e não tenha sido alterado ou modificado de qualquer maneira. Apenas os módulos 4501 livres de poeira e umidade devem ser instalados.

**INMETRO Certificado .....** **NCC 12.1306X**

### Marcas

[Ex ia Ga] IIC/IIB/IIA  
Ex nA nC IIC T4 Gc  
[Ex ia Da] IIIC

### Normas

IEC60079-15:2005, IEC60079-11:2011, IEC60079-0:2011  
IEC60079-26:2006

### Notas de instalação:

Instalação em grau de poluição 2, categoria de sobretensão II conforme definido no IEC 60664-1  
Não separe conectores quando energizado ou quando uma mistura de gás explosivo estiver presente.

Não monte ou remova módulos do trilho de alimentação quando uma mistura explosiva de gás estiver presente.

Desligue a alimentação antes da manutenção.

A fiação de terminais sem uso não é permitida.

A fonte de Loop e terminais de entrada de corrente para o mesmo canal não deve ser aplicada ao mesmo tempo.

Em tipo de proteção [Ex ia Da] os parâmetros para a segurança intrínseca para grupo de gás IIB são aplicáveis.

Para a instalação em Zona 2, o módulo deve ser instalado em um invólucro certificado conforme as normas da série ABNT NBR IEC 60079 que proporcione um grau de proteção de pelo menos IP54. Dispositivos de entrada de cabo e elementos de vedação devem cumprir com os mesmos requisitos.

Para a instalação de trilho de energia na Zona 2, apenas o trilho de alimentação Rail 9400 fornecido pela Unidade de Controle de Potência 9410 é permitido.

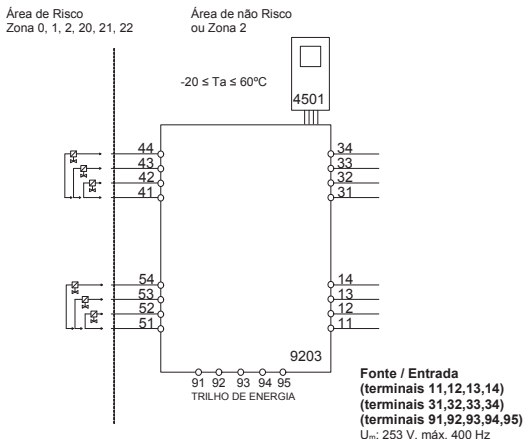

**Terminal (31,32)**

**Fonte:**

Voltagem 19,2 – 31,2 VDC  
Potência máx. 3,5 W

**Terminais (11,12 e 13,14)**

**Entrada:**

Voltagem máx. 28,VDC  
Gatilho: NPN Baixo < 2,V, Alto > 4,V  
Gatilho: PNP Baixo < 8,V, Alto > 10,V

**Terminais (33,34)**

**Relé de Estado:** Área de não Risco  
Voltagem máx. 125 VAC / 110 VDC  
Potência máx. 62,5 VA / 32 W  
Corrente máx. 0,5 AAC / 0,3 ADC

**Instalação Zona 2**

32 VAC / 32 VDC  
16 VA / 32 W  
0,5 AAC / 1 ADC

9203B1A, 9203B1B Terminais 41-42/51-52			Co	Lo	Lo/Ro	9203B2A Terminais 41-42			Co	Lo	Lo/Ro
U <sub>o</sub>	28V	IIC	80nF	4.2mH	54μH/Ω	U <sub>o</sub>	28V	IIC	80nF	2.69mH	44μH/Ω
I <sub>o</sub>	93 mA	IIB	640nF	16.8mH	218μH/Ω	I <sub>o</sub>	115mA	IIB	640nF	10.8mH	176μH/Ω
P <sub>o</sub>	0.65W	IIA	2.1μF	32.6mH	436μH/Ω	P <sub>o</sub>	0.81W	IIA	2.1μF	20.8mH	353μH/Ω
9203B1A, 9203B1B Terminais 41-43/51-53			Co	Lo	Lo/Ro	9203B2A Terminais 41-43			Co	Lo	Lo/Ro
U <sub>o</sub>	28V	IIC	80nF	3.5mH	50μH/Ω	U <sub>o</sub>	28V	IIC			
I <sub>o</sub>	100mA	IIB	640nF	14.2mH	201μH/Ω	I <sub>o</sub>	125mA	IIB	640nF	9.1mH	163μH/Ω
P <sub>o</sub>	0.70W	IIA	2.1μF	27.6mH	402μH/Ω	P <sub>o</sub>	0.88W	IIA	2.1μF	17.6mH	327μH/Ω
9203B1A, 9203B1B Terminais 41-44/51-54			Co	Lo	Lo/Ro	9203B2A Terminais 41-44			Co	Lo	Lo/Ro
U <sub>o</sub>	28V	IIC	80nF	2.9mH	46μH/Ω	U <sub>o</sub>	28V	IIC			
I <sub>o</sub>	110mA	IIB	640nF	11.8mH	184μH/Ω	I <sub>o</sub>	135mA	IIB	640nF	7.8mH	150μH/Ω
P <sub>o</sub>	0.77W	IIA	2.1μF	22.8mH	369μH/Ω	P <sub>o</sub>	0.95W	IIA	2.1μF	15.1mH	301μH/Ω

# **SAFETY MANUAL**

## **SOLENOID / ALARM DRIVER**

**9203**

**This safety manual is valid for the following product versions:**

**9203-001**

**9203-002**

## 0. CONTENTS

1. Observed standards .....	2
2. Acronyms and abbreviations .....	2
3. Purpose of the product .....	3
4. Assumptions and restrictions for use of the product.....	3
4.1 Basic safety specifications .....	3
4.2 Associated equipment.....	3
4.2.1 Safety output.....	3
4.2.2 Safety input.....	3
4.3 Failure rates .....	3
4.4 Safe parameterisation.....	4
4.5 Installation in hazardous areas .....	4
5. Functional specification of the safety functions.....	4
6. Functional specification of the non-safety functions .....	4
7. Safety parameters .....	4
8. Hardware and software configuration .....	5
9. Failure category.....	5
10. Periodic proof test procedure .....	5
11. Procedures to repair or replace the product.....	5
12. Maintenance.....	5
13. Documentation for routing diagram .....	6
13.1 In general .....	6
13.2 Further explanations .....	6
13.2.1 Password protection .....	6
13.4 Advanced functions.....	6
13.4.1 Display setup .....	7
13.4.2 Password .....	7
13.4.3 Language .....	7
13.4.4 Power rail .....	7
13.4.5 Safety integrity level.....	7
14 Safe parameterisation - user responsibility.....	8
14.1 Safety-related configuration parameters.....	8
14.2 Verification procedure.....	8
14.2.1 If no password is set.....	8
14.2.2 If password is set.....	9
14.3 Functional test.....	9
15. Fault reaction and restart condition .....	9
16 User interface .....	10
16.1 Scrolling help texts in display line 3.....	10
16.3 Routing diagram - Advanced settings (ADV.SET).....	12
17 Connections diagram .....	13

## 1. Observed standards

Standard	Description
IEC 61508	Functional Safety of electrical / electronic / programmable electronic safety-related systems
IEC 61508-2:2000	Part 2: Requirements for electrical / electronic / programmable electronic safety-related systems
IEC 61508-3:1998	Part 3: Software requirements
IEC 61326-3-1:2008	Immunity requirements for safety-related systems

## 2. Acronyms and abbreviations

Acronym / Abbreviation	Designation	Description
Element		Term defined by IEC 61508 as “part of a subsystem comprising a single component or any group of components that performs one or more element safety functions”
PFD	Probability of Failure on Demand	This is the likelihood of dangerous safety function failures occurring on demand.
PFH	Probability of dangerous Failure per Hour	The term “Probability” is misleading, as IEC 61508 defines a Rate.
SFF	Safe Failure Fraction	Safe Failure Fraction summarises the fraction of failures which lead to a safe state and the fraction of failures which will be detected by diagnostic measures and lead to a defined safety action.
SIF	Safety Integrity Function	Function that provides fault detection (to ensure the necessary safety integrity for the safety functions)
SIL	Safety Integrity Level	The international standard IEC 61508 specifies four discrete safety integrity levels (SIL 1 to SIL 4). Each level corresponds to a specific probability range regarding the failure of a safety function.

### 3. Purpose of the product

Universal Ex driver for the control of solenoids etc. with various Ex data by way of three built-in Ex barriers.

The device can be mounted in the safe area and in zone 2 / div. 2 and transmit signals to zone 0, 1, 2, 20, 21 and 22.

Ex driver for the control of ON / OFF solenoids, acoustic alarms and LEDs mounted in the hazardous area.

The 9203 is controlled by an NPN/PNP signal or a switch signal.

Monitoring of internal error events via the individual status relay and/or a collective electronic signal via the power rail.

The 9203 has been designed, developed and certified for use in SIL 2 applications according to the requirements of IEC 61508.

### 4. Assumptions and restrictions for use of the product

#### 4.1 Basic safety specifications

Operational temperature range .....	-20...+60°C
Storage temperature range .....	-20...+85°C
Power supply type, min.....	Double or reinforced
Supply voltage.....	19.2...31.2 VDC
Mounting area.....	Zone 2 / Division 2 or safe area
Mounting environment.....	Pollution degree 2 or better

#### 4.2 Associated equipment

##### 4.2.1 Safety output

The safety output shall be connected to the equipment with a minimum load of 10 K $\Omega$

##### 4.2.2 Safety input

The safety input signal frequency shall not be higher than 20 Hz, and the pulse length shall not be shorter than 25 ms.

#### 4.3 Failure rates

The basic failure rates from the Siemens standard SN 29500 are used as the failure rate database.

Failure rates are constant, wear-out mechanisms are not included.

External power supply failure rates are not included.

#### 4.4 Safe parameterisation

The user is responsible for verifying the correctness of the configuration parameters. (See section 14 Safe parameterisation - user responsibility). Manual override may not be used for safety applications.

#### 4.5 Installation in hazardous areas

The IECex Installation drawing, ATEX Installation drawing and FM Installation drawing shall be followed if the products are installed in hazardous areas.

### 5. Functional specification of the safety functions

Ex driver for the control of ON / OFF solenoids, acoustic alarms and LEDs mounted in the hazardous area.

### 6. Functional specification of the non-safety functions

The status relay (terminal 33 and 34), error signal on power rail (terminal 91) and LED outputs are not suitable for use in any Safety Instrumented Function.

### 7. Safety parameters

	B1A, B1B	B2A
Probability of dangerous Failure per Hour (PFH)	4.30E-08	4.60E-08
	Note <sup>1</sup>	
Probability of failure on demand (PFD) - 1 year proof test interval	2.73E-04	2.92E-04
Proof test interval (10% of loop PFD)	5 years	4 years
Safe Failure Fraction	91%	91%
Demand response time	<10 ms	
Demand mode	High	
Demand rate	1000 s	
Mean Time To Repair (MTTR)	24 hours	
Diagnostic test interval	10 seconds	
Hardware Fault Tolerance (HFT)	0	
Component Type	B	
SIL capability	SIL 2	
Description of the "Safe State"	De-energised	

Note<sup>1</sup>: The 9203 contains no lifetime limiting components, therefore the PFH figures are valid for up to 12 years, according to IEC 61508.



## 8. Hardware and software configuration

All configurations of software and hardware versions are fixed from factory, and cannot be changed by end-user or reseller.

This manual only covers products labelled with the product version (or range of versions) specified on the front page.

## 9. Failure category

Failure category	Failure rates (1/h)	
	B1A, B1B	B2A
Fail Safe Detected	0.00E+00	0.00E+00
Fail Safe Undetected	4.77E-07	4.80E-07
Fail Dangerous Detected	0.00E+00	0.00E+00
Fail Dangerous Undetected	4.30E-08	4.60E-08

## 10. Periodic proof test procedure

Step	Action
1	Bypass the safety PLC or take other appropriate action to avoid a false trip
2	Connect a simulator identical to the input setup
3	Perform an ON / OFF signal for each channel
4	Observe whether the output channel acts as expected
5	Restore the input terminals to full operation
6	Remove the bypass from the safety PLC or otherwise restore normal operation

This test will detect approximately 95% of possible “du” (dangerous undetected) failures in the device. The proof test is equivalent to the functional test.

## 11. Procedures to repair or replace the product

Any failures that are detected and that compromise functional safety should be reported to the sales department at PR electronics A/S.

Repair of the device and replacement of circuit breakers must be done by PR electronics A/S only.

## 12. Maintenance

No maintenance required.

## 13. Documentation for routing diagram

The routing diagram is shown in section 16.2.

### 13.1 In general

When configuring the 9203, you will be guided through all parameters and you can choose the settings which fit the application. For each menu there is a scrolling help text which is automatically shown in line 3 on the display.

Configuration is carried out by use of the 3 function keys:

- ⬆ will increase the numerical value or choose the next parameter
- ⬇ will decrease the numerical value or choose the previous parameter
- OK will accept the chosen value and proceed to the next menu

When configuration is completed, the display will return to the default state 1.0.

Pressing and holding OK will return to the previous menu or return to the default state (1.0) without saving the changed values or parameters.

If no key is activated for 1 minute, the display will return to the default state (1.0) without saving the changed values or parameters.

### 13.2 Further explanations

#### 13.2.1 Password protection

Access to the configuration can be blocked by assigning a password. The password is saved in the device in order to ensure a high degree of protection against unauthorised modifications to the configuration. Default password 2008 allows access to all configuration menus.

Password protection is mandatory in SIL applications.

### 13.4 Advanced functions

The unit gives access to a number of advanced functions which can be reached by answering “Yes” to the point “adv.set”.

#### **13.4.1 Display setup**

Here you can adjust the brightness contrast and the backlight. Setup of tag numbers with 5 alphanumerics. Selection of functional readout in line 2 and 3 of the display - choose between readout of digital output or tag no. When selecting "ALT" the readout toggles between digital output and tag no.

#### **13.4.2 Password**

Here you can choose a password between 0000 and 9999 in order to protect the device against unauthorised modifications to the configuration. The device is delivered default without password.

#### **13.4.3 Language**

In the menu "LANG" you can choose between 7 different language versions of help texts that will appear in the menu. You can choose between UK, DE, FR, IT, ES, SE and DK.

#### **13.4.4 Power rail**

In the menu "RAIL" you can choose if errors in the device are transmitted to the central surveillance in the PR 9410 power control unit.

#### **13.4.5 Safety integrity level**

See Safe parameterisation - user responsibility

## 14 Safe parameterisation - user responsibility

### 14.1 Safety-related configuration parameters

Parameters	Value	Description
CH1.FUN	DIR / INV	Direct / inverted channel function
CH2.FUN.	DIR / INV	Direct / inverted channel function
PASSW	0 - 9999	New password

The above safety-related configuration parameters are marked in red text in the routing diagrams and must be verified by the user in a SIL-configuration.

### 14.2 Verification procedure

The verification is done using the display / programming front PR 4501 by following the procedure described below.

#### 14.2.1 If no password is set

	Action	Display shows
1	Press OK	ADV.SET
2	Set (ADV.SET) to Yes and press OK	DISP SETUP
3	Step down to (SIL SETUP) and press OK	EN.SIL
4	Set (EN SIL) to YES and press OK	NEW.PASS
5	Set password to a number between 0 and 9999 and press OK (At this time the device starts operating in SIL mode with the entered configuration parameters!)	Verify⇒OPEN "briefly" ⇒LOCK*
6	Press OK to confirm verification of the OPEN-LOCK in the display	CH1.FUN
7	Verify Channel 1 function and press OK	CH2:FUN
8	Verify Channel 2 function and press OK	PASSW
9	Verify password and press OK	SIL.OK
10	Verify SIL and press OK	

\* Open is shown briefly in the display.

**14.2.2 If password is set**

	<b>Action</b>	<b>Display shows</b>
1	Press OK	PASSW
2	Enter password and press OK	ADV.SET
3	Set (ADV.SET) to Yes and press OK	DISP SETUP
4	Step down to (SIL SETUP) and press OK	EN.SIL
5	Set (EN SIL) to YES and press OK (At this time the device starts operating in SIL mode with the entered configuration parameters!)	Verify⇒OPEN "briefly" ⇒LOCK*
6	Press OK to confirm verification of the OPEN-LOCK in the display	CH1.FUN
7	Verify Channel 1 function and press OK	CH2:FUN
8	Verify Channel 2 function and press OK	PASSW
9	Verify password and press OK	SIL.OK
10	Verify SIL and press OK	

\* Open is shown briefly in the display

**14.3 Functional test**

The user is responsible for making a functional test after verification of safety parameters. The procedure for periodic proof test described in section 10 shall be used.

**15. Fault reaction and restart condition**

When the 9203 detects a fault the output will go to Safe State, in which the safety output will go to "de-energised".

For device faults there are 2 ways of bringing the device out of Safe State.

1. Power cycle the device.
2. Bring the device out of SIL mode (choose "NO" in the menu point "EN.SIL"), and set it back to SIL mode again (choose "YES" in the menu point "EN.SIL" and verify the configuration).

## 16 User interface

### 16.1 Scrolling help texts in display line 3

- [01] Set correct password
- [02] Enter advanced setup?
- [06] Enter language setup
- Enter password setup
- Enter display setup
- Enter SIL setup
- [07] Select direct channel function
- Select inverted channel function
- [09] Adjust LCD contrast
- [10] Adjust LCD backlight
- [11] Write a 5-character channel tag
- [12] Show output state in display
- Show output load in display
- Show tag in display
- Alternate information shown in display
- [13] Configuration SIL status (Open / Locked)
- [14] Enable SIL configuration lock
- [15] Enable password protection?
- [16] Set new password
- [17] Select language
- [20] No communication - check connections
- [21] EProm error - check configuration
- [22] Hardware error

## ROUTING DIAGRAM

If no key is activated for 1 minute, the display will return to the default state 1.0 without saving configuration changes.

- ⤴ Increase value / choose next parameter
- ⤵ Decrease value / choose previous parameter
- ⊗ Accept the chosen value and proceed to the next menu
- Hold ⊗ Back to previous menu / return to menu 1.0 without saving

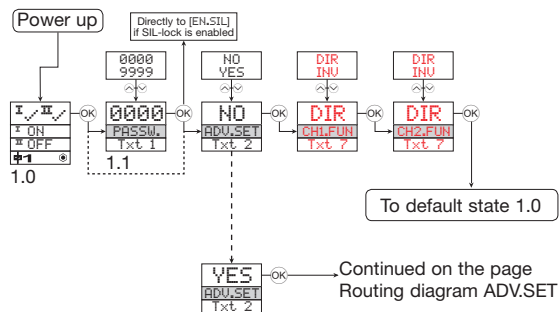

1.0 = Default state

Linie 1 shows status for channel 1 and channel 2.

Linie 2 shows output status for channel 1, output current or tag no.

Linie 3 shows output status for channel 2, output current or tag no.

Line 4 indicates whether the module is SIL-locked.

1.1 = Only if password-protected.

1.2 If password has been set.

Line 1 symbols:

I ✓ = OK. Flashing II = error.

Line 2 and 3 symbols:

I ON = channel 1 ON

II OFF = channel 2 OFF.

Line 4 symbols:

Static dot = SIL-locked.

Flashing dot = Not SIL-locked.

⚡ = output is active.

### 16.3 Routing diagram - Advanced settings (ADV.SET)

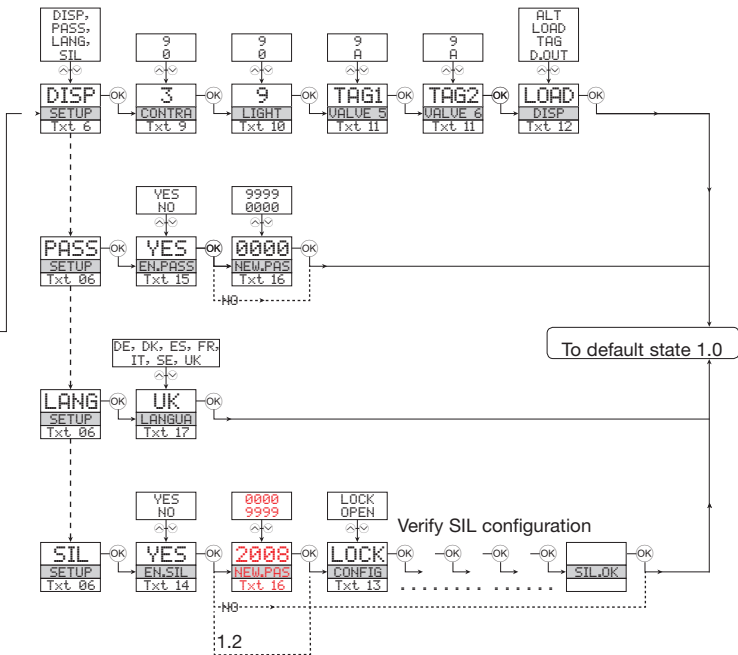



## 17 Connections diagram

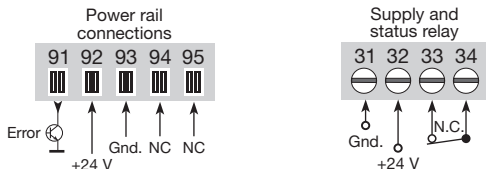

NC = No connection

### Inputs:

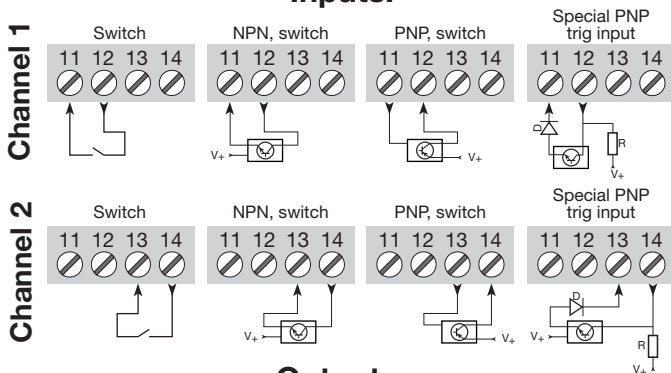

### Outputs:

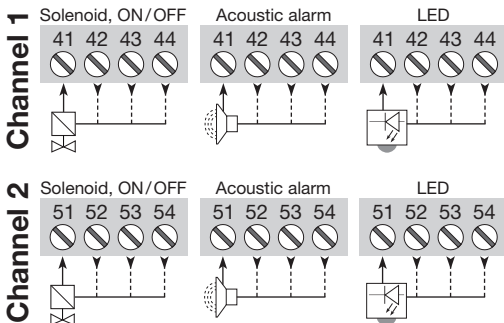



**Displays** Programmable displays with a wide selection of inputs and outputs for display of temperature, volume and weight, etc. Feature linearisation, scaling, and difference measurement functions for programming via PReset software.



**Ex interfaces** Interfaces for analogue and digital signals as well as HART® signals between sensors / I/P converters / frequency signals and control systems in Ex zone 0, 1 & 2 and for some devices in zone 20, 21 & 22.



**Isolation** Galvanic isolators for analogue and digital signals as well as HART® signals. A wide product range with both loop-powered and universal isolators featuring linearisation, inversion, and scaling of output signals.





























**Temperature** A wide selection of transmitters for DIN form B mounting and DIN rail devices with analogue and digital bus communication ranging from application-specific to universal transmitters.



**Universal** PC or front programmable devices with universal options for input, output and supply. This range offers a number of advanced features such as process calibration, linearisation and auto-diagnosis.



- 

[www.preelectronics.fr](http://www.preelectronics.fr)  

[sales-fr@preelectronics.com](mailto:sales-fr@preelectronics.com)
- 

[www.preelectronics.de](http://www.preelectronics.de)  

[sales-de@preelectronics.com](mailto:sales-de@preelectronics.com)
- 

[www.preelectronics.es](http://www.preelectronics.es)  

[sales-es@preelectronics.com](mailto:sales-es@preelectronics.com)
- 

[www.preelectronics.it](http://www.preelectronics.it)  

[sales-it@preelectronics.com](mailto:sales-it@preelectronics.com)
- 

[www.preelectronics.se](http://www.preelectronics.se)  

[sales-se@preelectronics.com](mailto:sales-se@preelectronics.com)
- 

[www.preelectronics.com](http://www.preelectronics.com)  

[sales-uk@preelectronics.com](mailto:sales-uk@preelectronics.com)
- 

[www.preelectronics.com](http://www.preelectronics.com)  

[sales-us@preelectronics.com](mailto:sales-us@preelectronics.com)
- 

[www.preelectronics.cn](http://www.preelectronics.cn)  

[sales-cn@preelectronics.com](mailto:sales-cn@preelectronics.com)
- 

[www.preelectronics.be](http://www.preelectronics.be)  

[sales-be@preelectronics.com](mailto:sales-be@preelectronics.com)

## Head office

Denmark  
 PR electronics A/S  
 Lerbakken 10  
 DK-8410 Rønne

[www.preelectronics.com](http://www.preelectronics.com)  
[sales-dk@preelectronics.com](mailto:sales-dk@preelectronics.com)  
 tel. +45 86 37 26 77  
 fax +45 86 37 30 85



QUALITY SYSTEM AND ENVIRONMENTAL  
 MANAGEMENT SYSTEM  
 DS/EN ISO 9001  
 DS/EN ISO 14001

